

PAT-4 UPGRADES
ASSEMBLY MANUAL
Line amp distortion reducer
Tone control switch

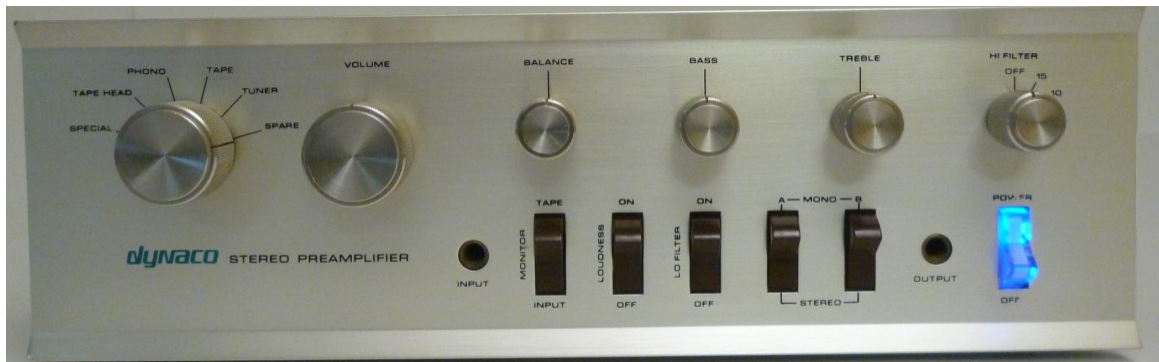

© 2013-2022 Akitika, LLC

All rights reserved

Revision 2p02

August 24, 2022

Table of Contents

Table of Contents.....	2
Table of Figures.....	2
Section 1: About This Manual.....	4
Who Should Attempt these Projects?.....	4
Tools You'll Need.....	4
Project Overview.....	5
Line Amp Distortion Reducer.....	5
Tone Control Switch.....	5
Important Safety Notes.....	5
Section 2: Line Amp Distortion Reducer.....	6
Line Amp Characteristics.....	6
How the Distortion Reduction Works.....	6
The Modification in a Nutshell.....	6
Preparing to Remove the Circuit Boards.....	6
Modifying the Left Channel Circuit board.....	7
Modifying the Right Channel Circuit board.....	11
Inspection and Reassembly.....	11
Section 3: Tone Control Switch.....	13
C16 Leakage and Replacement – Original Circuit boards.....	13
C16 Leakage and Replacement – PAT4RENEW boards.....	13
Pre-wiring the Tone Control Switch.....	13
Optional Gain Reducing Resistors.....	15
Disassembling the PAT-4 Preamp.....	16
Removing the HI FILTER switch.....	16
Mounting the tone control switch.....	17
Wiring in the tone control switch.....	17
If you are installing tone control switch with original Dynaco Circuit boards.....	18
If you are installing with PAT4RENEW boards ISSUE LENGTH OF WIRES????	18
Installing the Treble No-Click Resistors.....	19
Reassemble the PAT-4.....	20
Using the Tone Control Switch.....	20
Pops and Clicks – installing the tone control switch with original Dynaco channel boards.....	20
Gain Trim Resistors.....	21
Schematic.....	23
Appendix: The Toothpick Trick.....	24

Table of Figures

Figure 1-applying thermal compound and installing the heat sink on the MPSW45.....	8
Figure 2-Similar series of heat sink installation pictures for ZTX614.....	9
Figure 3-New transistor with heatsink installed on PCB.....	10
Figure 4-MPSW45A and ZTX614 Pinout.....	10
Figure 5-circuit board as seen from solder side. The modification replaces Q4.....	11

Figure 6-Switch Wiring Diagram. The gray dashed lines indicated relations between poles (center terminals) and throws (outer terminals). These gray lines are not on the actual switch. The gain resistors are optional, and not included with the kit 15

Figure 7-Installing the treble no-click resistors on eyelets 16, 17, and 18 19

Figure 8-Tone control switch installed and wired to bass control, treble control and PCB's (green wires called out in the assembly directions are blue in the pictures above). 22

Figure 9-Schematic of the preamp high level stage showing the addition of the tone control switch..... 23

Section 1: About This Manual

This manual gives the information you need to build and install the various upgrades to the Dynaco PAT-4 Preamp. As of this writing, the following PAT-4 upgrades are available from Updatemydynaco, a division of Akitika LLC:

- Blue Light Kit (not covered in this manual)
- Line Amp Distortion Reducer
- Tone Control Switch

The Line Amp Distortion Reducer drops the distortion of the Line Amp by a factor of ten. The Line Amp is the stage that includes the volume and tone controls. All sound from the preamp passes through the Line Amp. This upgrade should make everything played through the PAT-4 sound better.

The Tone Control Switch replaces the existing Hi Filter switch with a two-position rotary switch. In the OFF position, the tone controls are disabled. In the 15 position, tone controls maintain their normal function. After this modification, the other two positions of the HI FILTER switch (10 and 7) are not available. You can install optional resistors (not provided) that drop the Line Amp gain when the tone controls are off. This drops the gain of the Line Amp, increasing Signal to Noise Ratio.

These upgrades can be installed in any combination.

Who Should Attempt these Projects?

You can build this kit if you can:

1. solder (using normal rosin core solder and a soldering iron).
2. use simple hand tools like screwdrivers, wire cutters, and pliers.
3. read and follow directions.

It helps if you:

1. know a bit about electronics, or
2. have a friend who knows a bit about electronics
3. can get to YouTube to watch a few helpful videos about the assembly process (not available as of this version of the manual)

Tools You'll Need

You'll need the following tools:

1. flat blade screwdriver for #6 screws
2. needle nose pliers (helpful, but not strictly necessary)
3. pencil type soldering iron of 25 to 50 Watts (no huge honking soldering guns or blowtorches)
4. wire cutters and strippers
5. Magnifying glass, if you're over 42!

Project Overview

Line Amp Distortion Reducer

The project consists of the following steps:

1. Labeling, then desoldering 7 wires from each circuit board.
2. Removing and replacing 1 transistor from each circuit board.
3. Re-attaching the wires to the circuit boards.

Tone Control Switch

The project consists of the following steps:

1. Building the tone control switch assembly
2. Removing the High Filter switch
3. Wiring in the Tone Control Switch

NOTE:

- Section 2: Line Amp Distortion Reducer, applies to the Line Amp Distortion Reducer.
- Section 3: Tone Control Switch, applies to the Tone Control Switch.

Use the appropriate section for the job at hand.

Important Safety Notes

By purchasing, using, or assembling this kit, you have agreed to hold AkitikA, LLC harmless for any injuries you may receive in its assembly and/or use. To prevent injuries:

- Wear safety glasses when soldering to prevent eye injuries.
- Always unplug the power before working on the amplifier.
- Large capacitors hold lots of energy for a long time. Before you put your hands into the amplifier:
 - Pull the AC plug!
 - Wait 1 full minute for the capacitors to discharge!
- Remove jewelry and rings from your hands and wrists, or anything that might dangle into the amplifier.
- If working in the amplifier, keep one hand in your pocket, especially if you're near the power supply or power supply wires. This can prevent serious shocks.
- Build with a buddy nearby. If you've ignored all the previous advice, they can dial 911 or get you to the hospital.

Section 2: Line Amp Distortion Reducer

Line Amp Characteristics

The line amp in a properly working PAT-4 has about 0.02% distortion when driving a 100K Ohm load at 1 Volt RMS. Typical units measure about -74 dB for the second harmonic of a 1 kHz test signal, and perhaps -90 dB for the third harmonic. Distortion increases for lower impedance loads and at higher levels.

By making the modification described herein, you can drop the 2nd Harmonic to about 94 dB below the fundamental and make the 3rd harmonic invisible. That corresponds to about 0.002% distortion, rivaling the best preamps. Distortion reduces with reduced output level.

How the Distortion Reduction Works

This modification changes Q4, a standard bipolar transistor, for the T0-92 Darlington transistor and heat-sink supplied in the kit. The Darlington transistor greatly diminishes the loading of the output stage on the first gain stage, increasing the overall open loop gain. This leaves the closed loop gain essentially unchanged but reduces distortion by a factor of nearly 10.

The Modification in a Nutshell

You will be replacing Q4 with the supplied transistor and heat sink. If you're quite familiar with the PAT-4, that's probably all you need to know. Otherwise, you may find the information in the following sections helps you keep your place and avoid trouble.

Preparing to Remove the Circuit Boards

1. Disconnect the PAT-4 from your music system.
2. Unplug the power cord and allow the preamp to sit for one minute before moving on.

Caution: Be sure that the preamp power is unplugged! 120 VAC can be lethal! 240 VAC can be lethal!

3. Remove the 4 screws that hold the cover in place, 2 on the left side and 2 on the right side.
4. Lift the cover straight up and set it aside in a safe place.
5. Get masking tape and a pen ready. You will be labeling the wires that you are about to remove.
6. Desolder the following wires from the left channel PC board, the one closer to the back of the preamp. As you remove each wire, place a clearly marked masking tape label on the wire with the number of the eyelet from which the wire was removed. *If you think it's helpful, add the letter R or L to the tag to designate Right or Left channel. It may be easier instead to use F or B for front or back PC Board.* Don't put too much stress on the selector switch as you remove these wires.
 - a. Eyelet 1
 - b. Eyelet 2

- c. Eyelet 4
 - d. Eyelet 5
 - e. Eyelet 6
 - f. Eyelet 7
7. Repeat the process for the right channel PC board, the one closer to the front of the preamp. As you remove each wire, place a clearly marked masking tape label on the wire with the number of the eyelet from which the wire was removed. Don't put too much stress on the selector switch as you remove these wires.
 - a. Eyelet 1
 - b. Eyelet 2
 - c. Eyelet 4
 - d. Eyelet 5
 - e. Eyelet 6
 - f. Eyelet 7
 8. You may want to use the Toothpick Trick (see page 24) to clear the solder from these eyelets. Doing so will make reassembly much easier.
 9. Remove the two 6-32 nuts, lock washers, and screws that hold the U-shaped brackets that retain the circuit boards on the bottom of the chassis.
 10. Slowly rotate the bottom of the circuit boards toward the back of the preamp until the boards are approximately horizontal. Many solid wires remain on the circuit board, but with care it can be slowly rotated to the horizontal position.
 11. You're now looking down on the component side of the left channel circuit board.

Modifying the Left Channel Circuit board

Now it's time for a judgment call. You probably have enough access to the left channel PCB that you can remove Q4, the metal transistor with the clip-on heat-sink, with no further disassembly. You can even replace Q4 with the supplied TO-92 transistor and heat sink with no further disassembly. If however, you are uncomfortable with this, the following directions may help.

1. Remove the 4 screws that hold the left channel circuit board into the U-shaped bracket. This should give you enough freedom of motion with the circuit board that changing Q4 can be fairly easy.
2. To Remove Q4:
 - a. Slip off the clip-on heat-sink.
 - b. Desolder each of the three leads in turn.
 - c. Remove the transistor
3. Preparing for the new Q4 (Figure 1, left channel):
 - a. Taking each of the three leads in turn, heat the pads on the PCB into which Q4 was installed. Run a toothpick into the accompanying eyelet from the component side of the board. This will clear the hole, allowing the new Q4's leads to be installed. For more information, see page 24.
 - b. Smear a film of thermal compound onto the T0-92 transistor and insert a heat sink over its body. Be careful to keep heat sink compound off the leads.
 - c. Insert the leads of the MPSW45A (ZTX614 if you have Rev 2) transistor into the space for Q4, matching emitter, base, and collector to the

indicated places. Note that the emitter of the transistor goes toward the bottom of the PCB (away from the eyelets, see Figure 5).

- d. Solder the three leads of the new transistor in place.

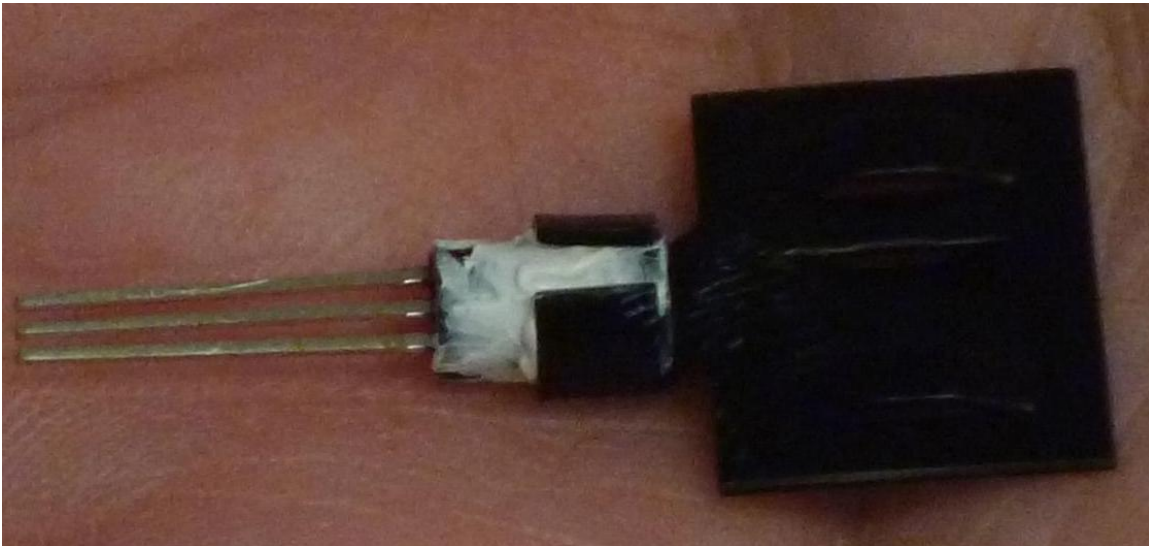
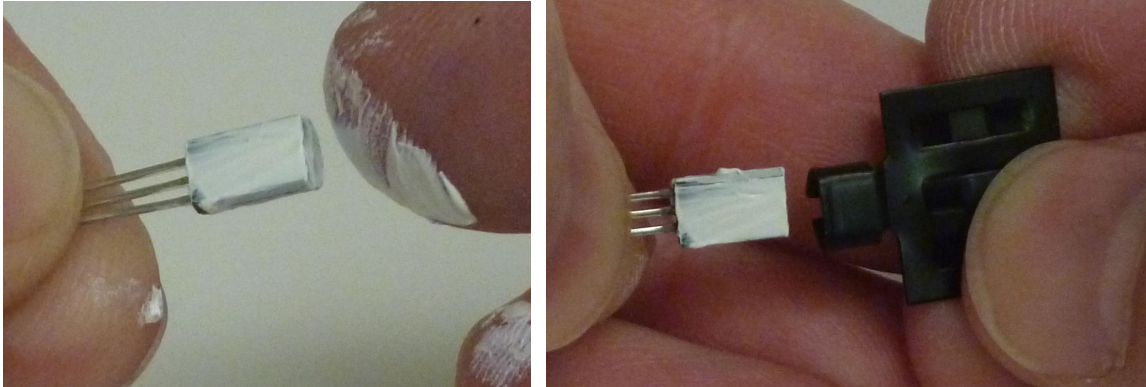

Figure 1-applying thermal compound and installing the heat sink on the MPSW45

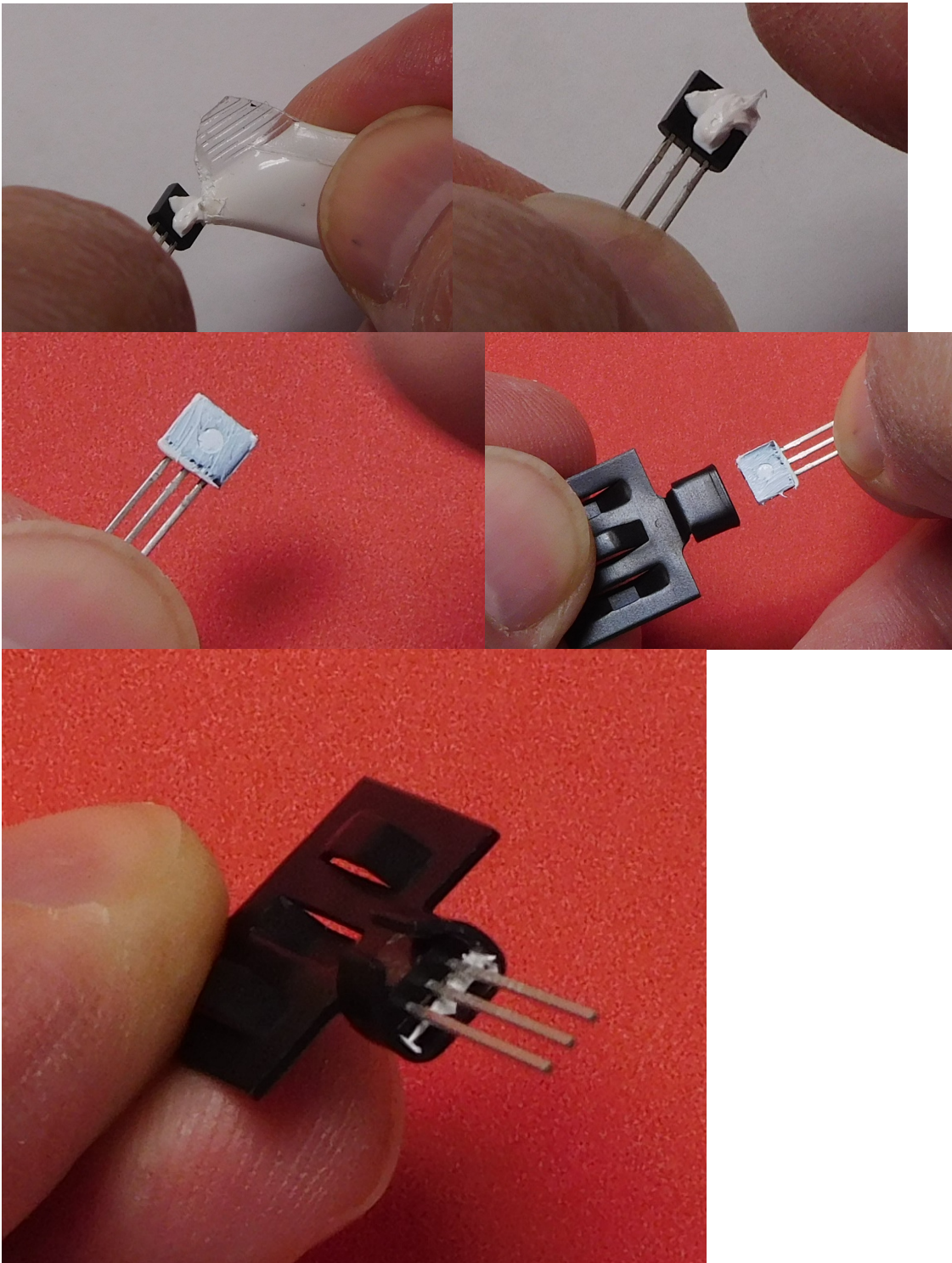

Figure 2-Similar series of heat sink installation pictures for ZTX614



Figure 3-New transistor with heatsink installed on PCB

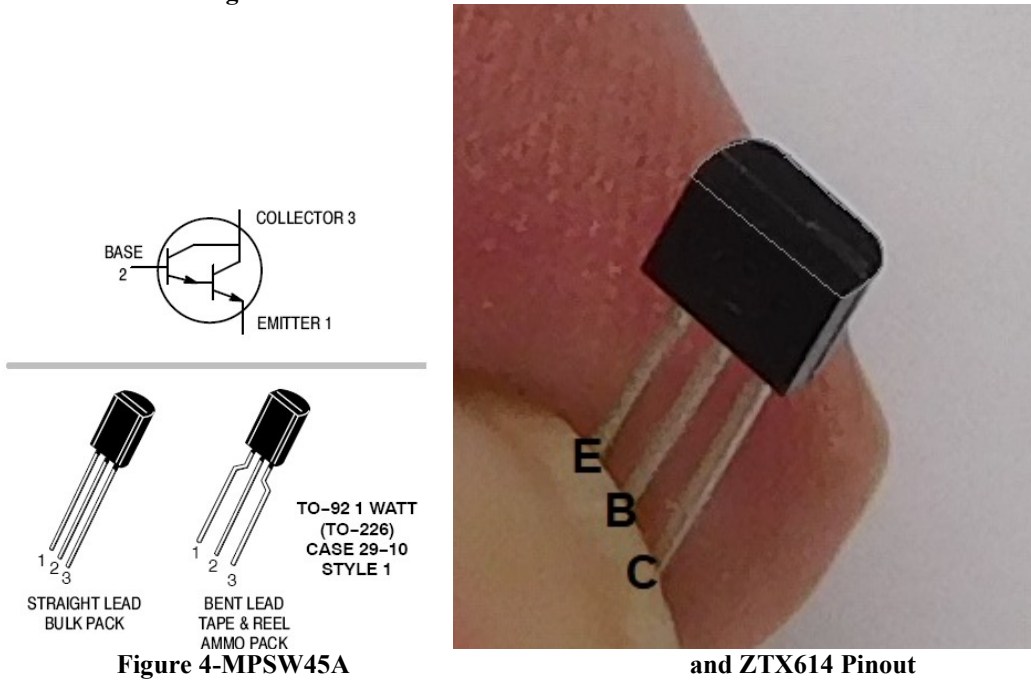

Figure 4-MPSW45A

and ZTX614 Pinout

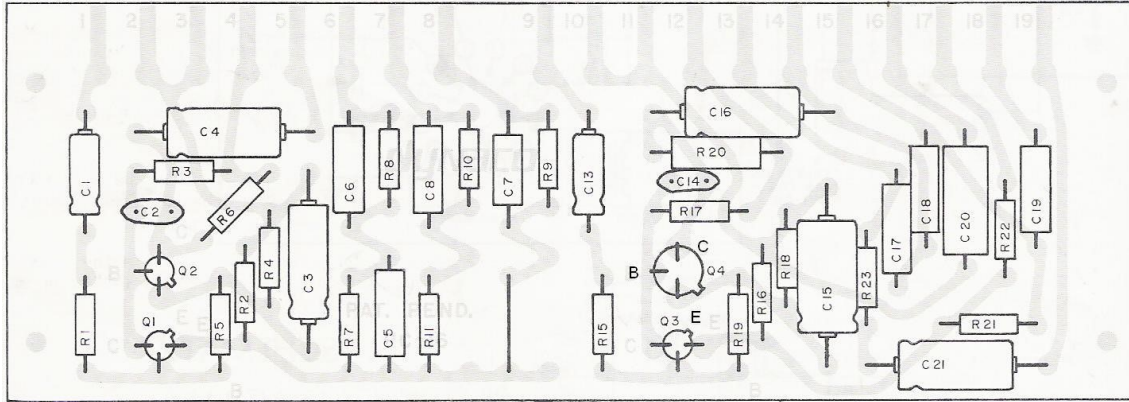

Figure 5-circuit board as seen from solder side. The modification replaces Q4

Modifying the Right Channel Circuit board

Now it's time for a second judgment call. You probably have enough access to the right channel PCB that you can remove Q4, the metal transistor with the clip-on heat-sink, with no further disassembly. You can even replace Q4 with the supplied TO-92 transistor and heat sink with no further disassembly. If however, you are uncomfortable with this, the following directions may help.

4. Remove the 4 screws that hold the right channel circuit board into the U-shaped bracket. This should give you enough freedom of motion with the circuit board that changing Q4 can be fairly easy.
5. To Remove Q4:
 - a. Slip off the clip-on heat-sink.
 - b. Desolder each of the three leads in turn.
 - c. Remove the transistor
6. Preparing for the new Q4 (Figure 1, right channel):
 - a. Taking each of the three leads in turn, heat the pads on the PCB into which Q4 was installed. Run a toothpick into the accompanying eyelet from the component side of the board. This will clear the hole, allowing the new Q4's leads to be installed.
 - b. Smear a film of thermal compound onto the T0-92 transistor and insert a heat sink over its body. Be careful to keep heat sink compound off the leads.
 - c. Insert the leads of the MPSW45A (or ZTX614 if you have Rev 2) transistor into the space for Q4, matching emitter, base, and collector to the indicated places. Note that the emitter of the transistor goes toward the bottom of the PCB (away from the eyelets).
 - d. Solder the three leads of the new transistor in place.

Inspection and Reassembly

Inspect your work for good solder joints and freedom from solder bridges. Assuming that is satisfactory:

1. Reassemble the PCB's to the U-shaped retaining bracket.
2. Solder the numbered wires into the numbered eyelets on the PCBs. Make sure not to mix left and right channel wires up.

3. Re-fasten the u-shaped brackets to the bottom of the chassis.
4. Reinstall the cover using the 4 screws (2 on each side) that hold it in place.
5. You're ready to listen to music with lower distortion.

Section 3: Tone Control Switch

There are two installation cases to consider:

1. Installation into a PAT-4 with original circuit boards.
2. Installation into a PAT-4 with the PAT4RENEW boards.

C16 Leakage and Replacement – Original Circuit boards

It's important to check C16 for leakage. The quickest and easiest way to do so is to rotate the bass control while the PAT-4 is connected to your power amp and speakers. Listen carefully for a scratching sound as you rotate the Bass pot.

If you hear the scratching sound on either channel, then clean the bass pot using a spray cleaner. If the scratching sound persists, then C16 for both left and right channels should be replaced. More details can be found in the section "Pops and Clicks" on page 20.

C16 Leakage and Replacement – PAT4RENEW boards

The PAT4RENEW boards will be new, so their capacitors will not be leaky. The two supplied axial capacitors will not be used. Feel free to put them in your spares cupboard.

Pre-wiring the Tone Control Switch

This section covers the pre-wiring of the tone control switch. Figure 6 contains a large diagram of the switch wiring. Cross check the directions here with the diagram.

Prepare the following 6 wires:

1. 6" length of red wire, then strip ¼" of insulation from one end
2. a second 6" length of red wire, then strip ¼" of insulation from one end of this wire also.
3. 6" length of black wire, then strip ½" of insulation from one end.
4. 7" length of green wire, then strip ¼" of insulation from one end
5. a second 7" length of green wire, then strip ¼" of insulation from one end of this wire also.
6. A 7" length of black wire, then strip ½" of insulation from one end of this wire also.

Refer to Figure 6. Make sure you have oriented the switch as shown in the Figure. **The ALPHA designation, stamped in the metal, must be facing up.**

1. Bend a hook in the ¼" uninsulated portion of a red wire, insert it through the upper BASS 1 hole, and crimp it in place. Solder the wire.
2. Bend a hook in the ¼" uninsulated portion of the second red wire, insert it through the upper BASS 3 hole, and crimp it in place. Solder the wire.
3. Place the ½" uninsulated portion of a black wire into the upper BASS 2 hole, and continue with the same uninsulated portion of that wire, inserting it in the adjacent terminal, as marked by the yellow line in Figure 6. Solder the wire to both terminals.

4. Dress the wires from steps 1-3 off to the right, keeping them together. A piece of masking tape around the wires may be helpful.
5. Bend a hook in the ¼" uninsulated portion of a green wire, insert it through the lower BASS 1 hole, and crimp it in place. Solder the wire.
6. Bend a hook in the ¼" uninsulated portion of the second green wire, insert it through the lower BASS 3 hole, and crimp it in place. Solder the wire.
7. Place the ½" uninsulated portion of the remaining black wire into the lower BASS 2 hole, and continue with the same uninsulated portion of that wire, inserting it in the adjacent terminal, as marked by the yellow line in Figure 6. Solder the wire to both terminals.
8. Dress the wires from steps 5-7 off to the right, keeping them together. A second piece of masking tape around the wires may be helpful.

Prepare the following 4 wires:

1. 4" length of red wire, then strip ¼" of insulation from one end.
2. 4" length of green wire, then strip ¼" of insulation from one end.
3. 8" length of black wire, then strip ¼" of insulation from one end.
4. a second 8" length of black wire, then strip ¼" of insulation from one end.

Refer to Figure 6. Make sure you have oriented the switch as shown in the Figure. **The ALPHA designation, stamped in the metal, must be facing up.**

1. Bend a hook in the ¼" uninsulated portion of the red wire, insert it through the upper TREBLE CENTER hole, and crimp it in place. Solder the wire.
2. Bend a hook in the ¼" uninsulated portion of a black wire, insert it through the upper 17 hole, and crimp it in place. Solder the wire.
3. Dress the wires from steps 1-2 together. A piece of masking tape may help keep them together, making them easier to identify in final assembly.
4. Bend a hook in the ¼" uninsulated portion of the green wire, insert it through the lower TREBLE CENTER hole, and crimp it in place. Solder the wire.
5. Bend a hook in the ¼" uninsulated portion of the second black wire, insert it through the lower 17 hole, and crimp it in place. Solder the wire.
6. Dress the wires from steps 4-5 together. A piece of masking tape may help keep them together, making them easier to identify in final assembly.

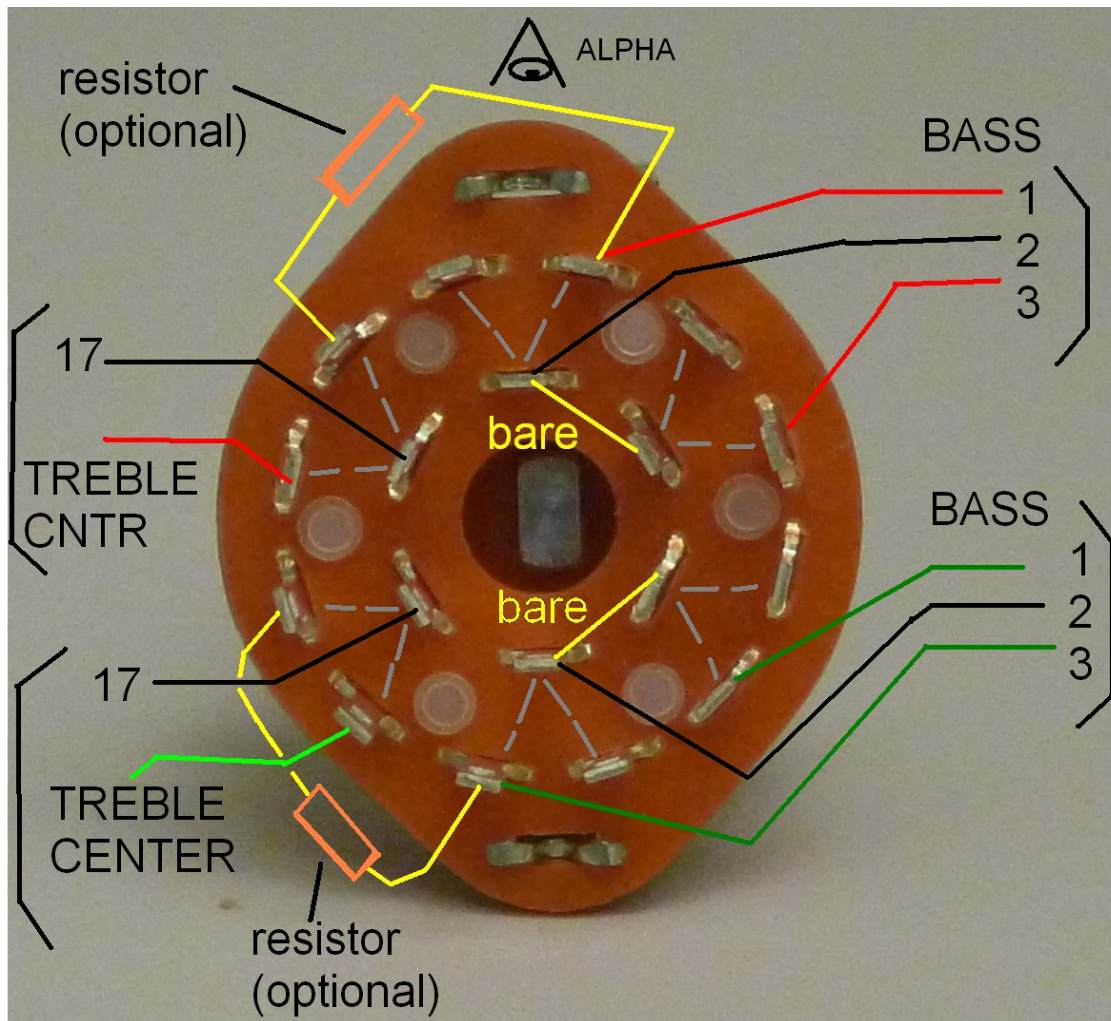

Figure 6-Switch Wiring Diagram. The gray dashed lines indicated relations between poles (center terminals) and throws (outer terminals). These gray lines are not on the actual switch. The gain resistors are optional, and not included with the kit

Check Your Work

Review your work against Figure 6. All of the 6 terminals in the center ring should have a soldered connection. Check for the correct soldered and open terminals in the outer ring.

Optional Gain Reducing Resistors

This section describes an optional step. Should you desire, at the same time that the tone controls are turned off, you can decrease the gain of the high level stage. This increases the Signal to Noise Ratio of the preamp. I'll present the arguments for and against, but you'll have to decide.

Note: gain reducing resistors are not included in this kit! The resistors that are included in the kit are the 4.7 Meg-Ohm "no-click" resistors. Their installation is described on Installing the Treble No-Click Resistors, on page 19.

Add the Gain Reducing Resistors

- If you never run the volume control past 11 O'clock, and
- You don't mind that the gain with the tone control off will be less than the gain with the tone control on.

These resistors aren't needed. The modification works perfectly well without them. Installing them gives you the opportunity to customize your preamp a bit more to your personal preferences. Note that if you routinely max out the volume control on your PAT-4, this step is not recommended.

Should you decide that you want to reduce the gain of the preamp for the reasons described above, you'll have to decide how much gain reduction you want. Page 21 has a table of the resistor values and their resulting gain reductions.

To install the gain reducing resistors, follow these steps, referring to Figure 6.

1. Form the leads of one of the resistors so that its ends can solder to the indicated terminals on the upper portion of the switch. One lead goes onto the already soldered upper BASS 1 wire. Refer to Figure 6 for the location of the second lead of the upper resistor.
2. Form the leads of the second resistor so that its ends can solder to the indicated terminals on the lower portion of the switch. One lead goes onto the already soldered lower BASS 3 wire. Refer to Figure 6 for the location of the second lead of the lower resistor.

The Tone Control Switch is now ready for installation.

Disassembling the PAT-4 Preamp

Disconnect your PAT-4 from your music system. Make sure that the power cord is out, and has been out for at least 1 minute before starting this section.

Here are the steps to disassemble the PAT-4 preamp to the extent you'll need to in order to gain access to remove the Filter switch and replace it with the Tone Control Switch.

1. Remove the 4 sheet metal screws (two on each side) that hold the cover of the chassis in place.
2. Lift the cover off the chassis.
3. Center all the rotary controls. This will make it easier to put the knobs back at the right orientation. They must be removed to remove the front panel.
4. Carefully loosen the set screws in all the knobs. Remove the knobs and store them in a safe place.
5. Remove the retaining nuts on the control shafts which hold the front panel to the sub-chassis.
6. Remove the front panel and set it aside in a safe place.
7. Remove the nut that retains the HI FILTER switch.

Removing the HI FILTER switch.

The switch is held in by 6 wires:

- 2 black ground wires
- 2 green wires that carry left channel output signals
- 2 red wires that carry right channel output signals

To remove the HI FILTER switch:

1. Cut the 6 wires near where they enter the HI FILTER switch.
2. Coil the two black wires, leaving them out of the way; near, but not making electrical contact to, the bottom of the chassis.
3. splice the two green wires together.
4. splice the two red wires together.

Mounting the tone control switch

1. Prior to installing the tone control switch, carefully bend the locator tab flat using small pliers.
2. Remove both nuts from the shaft of the switch but leave the washer in place. One of the nuts fastens the switch to bare chassis. The other nut will hold the front panel to the chassis in final assembly.
3. Install the tone control switch through the front panel from the inside of the chassis, making sure that the ALPHA stamped portion of the switch faces up.
4. Slide one of the retaining nuts over the switch shaft and tighten it, making sure that the switch is vertical. You can check the orientation by temporarily installing the knob from the HI FILTER switch on the shaft of the tone control switch. The set screw should make contact with the flat side of the D-shaped shaft.
5. Turn the knob counter-clockwise. The indicator line should be at 12 o'clock if the switch has been installed straight up and down.

Wiring in the tone control switch

1. Desolder the wire that connects to the right channel circuit board eyelet 17. The right channel circuit board is closest to the front of the preamp. I've found the best way to do this is:
 - a. Heat the solder side of the eyelet 17 connection. When the solder flows, pull the wire out with needle nose pliers.
 - b. Get a toothpick ready to insert into eyelet 17 from the component side. Heat the solder side of eyelet 17 again, and push and turn the toothpick into the hole from the component side of eyelet 17. This clears the hole for later insertion of a new wire.
2. Desolder the other end of this wire from the center terminal of the treble pot. The right channel treble pot is closest to the front panel of the preamp.
3. Similarly, desolder the wire that connects to the LEFT channel circuit board eyelet 17. The left channel circuit board is closest to the back of the preamp. Use the toothpick to clear the hole as described above.
4. Desolder the other end of this wire from the center terminal of the left channel portion of the treble pot. The left channel portion of the treble pot is closest to the back panel of the preamp.
5. Identify the red and black pair of wires which in Figure 6 are identified as TREBLE CENTER and 17 in the upper left half of the Figure.
 - a. Route the black wire of the pair to eyelet 17 of the right channel PCB (closest to the front of the preamp). Cut it to a comfortable length, strip off ¼" of insulation, insert it through eyelet 17, and solder it on the solder side of the board.

- b. Route the red wire of the pair to the open center terminal of the portion of the treble pot closest to the front panel. Remove ¼” of insulation, and solder the wire to the middle terminal of the pot.
6. Identify the green and black pair of wires which in Figure 6 are identified as TREBLE CENTER and 17 in the lower left half of the Figure.
 - a. Route the black wire of the pair to eyelet 17 of the left channel PCB (closest to the back of the preamp). Cut it to a comfortable length, strip off ¼” of insulation, insert it through eyelet 17, and solder it on the solder side of the board.
 - b. Route the green wire of the pair to the open center terminal of the portion of the treble pot closest to the back panel. Remove ¼” of insulation, and solder the wire to the middle terminal of the pot.

If you are installing tone control switch with original Dynaco Circuit boards

1. Identify the red-black-red trio of wires that connect to the upper right half of the switch as shown in Figure 6. Form the trio over towards the bass pot, the group of terminals that connect to the front section of the bass pot.
 - a. Connect one of the red wires to an outside terminal. This will be in addition to the wire already in place that connects the pot to a PC board.
 - b. Connect the second red wire to the other outside terminal of the front section of the POT. It doesn't matter which red wire goes to which outside terminal. (there is already a wire on this terminal also).
 - c. Connect the black wire to the center terminal of the front section of the bass pot, joining the wire that is already there.
2. Identify the green-black-green trio of wires that connect to the lower right half of the switch as shown in Figure 6. Form the trio over towards the bass pot, the group of terminals that connect to the rear section of the bass pot.
 - a. Connect one of the green wires to an outside terminal. This will be in addition to the wire already in place that connects the pot to a PC board.
 - b. Connect the second green wire to the other outside terminal of the rear section of the POT. It doesn't matter which green wire goes to which outside terminal. (there is already a wire on this terminal also).
 - c. Connect the black wire to the center terminal of the rear section of the bass pot, joining the wire that is already there.

If you are installing with PAT4RENEW boards ISSUE LENGTH OF WIRES????

1. Identify the red-black-red trio of wires that connect to the upper right half of the switch as shown in Figure 6. Form the trio over towards the right channel (front) circuit board. You'll notice that Eyelets 13, 14, and 15 are double, with an upper and lower row of holes. The bass pot will probably be connected to the upper row of holes. You will connect the tone control switch wires to the lower row of holes.
 - a. Connect one of the red wires Eyelet 13 in the lower row.
 - b. Connect the second red wire to Eyelet 15 in the lower row.
 - c. Connect the black wire to Eyelet 14.

2. Identify the green-black-green trio of wires that connect to the upper right half of the switch as shown in Figure 6. Form the trio over towards the left channel (rear) circuit board. You'll notice that Eyelets 13, 14, and 15 are double, with an upper and lower row of holes. The bass pot will probably be connected to the upper row of holes. You will connect the tone control switch wires to the lower row of holes.
 - a. Connect one of the green wires Eyelet 13 in the lower row.
 - b. Connect the second green wire to Eyelet 15 in the lower row.
 - c. Connect the black wire to Eyelet 14.

Installing the Treble No-Click Resistors

If you have PAT4RENEW Circuit boards, this function is already built-in. There is **no need to perform this step if you have installed the PAT4RENEW** circuit boards. Skip ahead to “Reassemble the PAT-4”.

If you have original PAT4 circuit boards, then you will add the resistors as shown in this section.

Prepare a two-resistor combination follows for the left channel.

1. Take two 4.7 Meg resistors. Twist one lead of each with one lead of the other. Each resistor will have one free lead.
2. Form the leads so they can be soldered to eyelets 16, 17, and 18.
3. Tin the twisted leads and the free leads so they can be more easily attached to the PC board.
4. Solder the resistor leads in place as shown in Figure 7.
5. Repeat the process for the right channel circuit board. You may have to move some of the wires to the side to avoid melting them, but you should have pretty easy access to the three eyelets.



Figure 7-Installing the treble no-click resistors on eyelets 16, 17, and 18

Reassemble the PAT-4

Check the 10 added wires to assure that your solder joints are strong and that nothing has come undone.

- The bass pot has 12 wires, 6 original, and 6 added. Each terminal of the bass control has 2 wires.
- The treble control has 6 wires, but the center terminal of both sections now goes to the tone control switch.
- Replace the front panel of the preamp, retaining it in place using the same nuts on the same controls as prior to disassembly.
- Use the previously reserved nut from the Tone Control Switch kit to fasten the front panel in the area of the new tone control switch.
- Attach the knobs to their shafts and tighten their respective set screws.
- Replace the cover on the chassis, and re-insert the 4 screws that hold the cover in place.

Using the Tone Control Switch

If you have followed the directions, the OFF position of the HI FILTER switch turns off the tone controls. The 15 position of the HI FILTER switch turns the tone controls on. If you have not installed gain changing resistors, then going between the OFF and 15 positions has the effect of removing the tone control action without changing the gain.

The 10 and 7 positions of the high filter switch are not available after the modification is completed.

Pops and Clicks – installing the tone control switch with original Dynaco channel boards

Skip this section if you are installing the tone control switch with PAT4RENEW boards.

There should be no pops or clicks when switching between the on and off position. If there's a loud pop, and if it gets worse with more bass boost, then you'll probably find that C16 has become leaky. Another sign of a leaky C16 is a scratchy bass control, even after it has been cleaned.

It's probably best to just replace C16, but there's an interesting leakage test you can perform:

1. Work safely, disconnecting the PAT-4 from power before working on it.
2. Desolder the negative end of C16.
3. Connect the desoldered negative end of C16 to the positive lead of a DC micro-ammeter. Connect the negative lead of the meter to ground.
4. Remaining clear of the exposed 120 Volts, plug the PAT-4 in and power it up.
5. Observe the DC micro-ammeter. As the capacitor charges at first, there will be significant charging current. After a few seconds, it should subside to zero.
6. Note that 0.02 mA (20 uA) is definitely not zero! A typical bad capacitor will have that much leakage. A good capacitor should have much less than 1 uA of leakage current.

C16 is originally 50 μF , but 47 μF is an equally fine replacement. It should have a working voltage rating of greater than or equal to 25 Volts.

Why does C16 become leaky? It sits right above R20, a 620 Ohm, 1 Watt resistor that dissipates about 640 mW. In most of examples I've seen, C16 actually touches R20. The heat is probably the cause of the failure. Replacement caps typically have a bit smaller diameter, putting some space between themselves and R20. This should enhance the life of the new cap.

Finally, it's probably a good idea to replace C16 in both left and right channels.

If there's a click, re-check the solder joints on the 4.7 MegOhm resistors added to eyelets 16, 17, and 18, as shown in Figure 7.

Gain Trim Resistors

A gain trim resistor is a bit of a two-edged sword. The 1210 Ohm value is about the lowest value that should be used. It reduces the gain, but it also increases the loading on the output stage. The net effect is positive...if indeed you needed less gain, then the 1210 resistor drops the gain, increasing the SNR for the high level stage.

Here is a table of other values for the gain trim resistors, and their effect on the flat gain of the high level stage.

Gain Trim Resistor Value	Gain Reduction
Open circuit	0 dB (e.g. no effect)
22K	1.53 dB
10K	3.02 dB
6800	4.08 dB
3300	6.7 dB
2200	8.46 dB
1210 or 1200 Ohms	11.23 dB

The unmodified high level stage has about 21 dB of gain when driving a high impedance load and the volume control is turned fully clockwise.

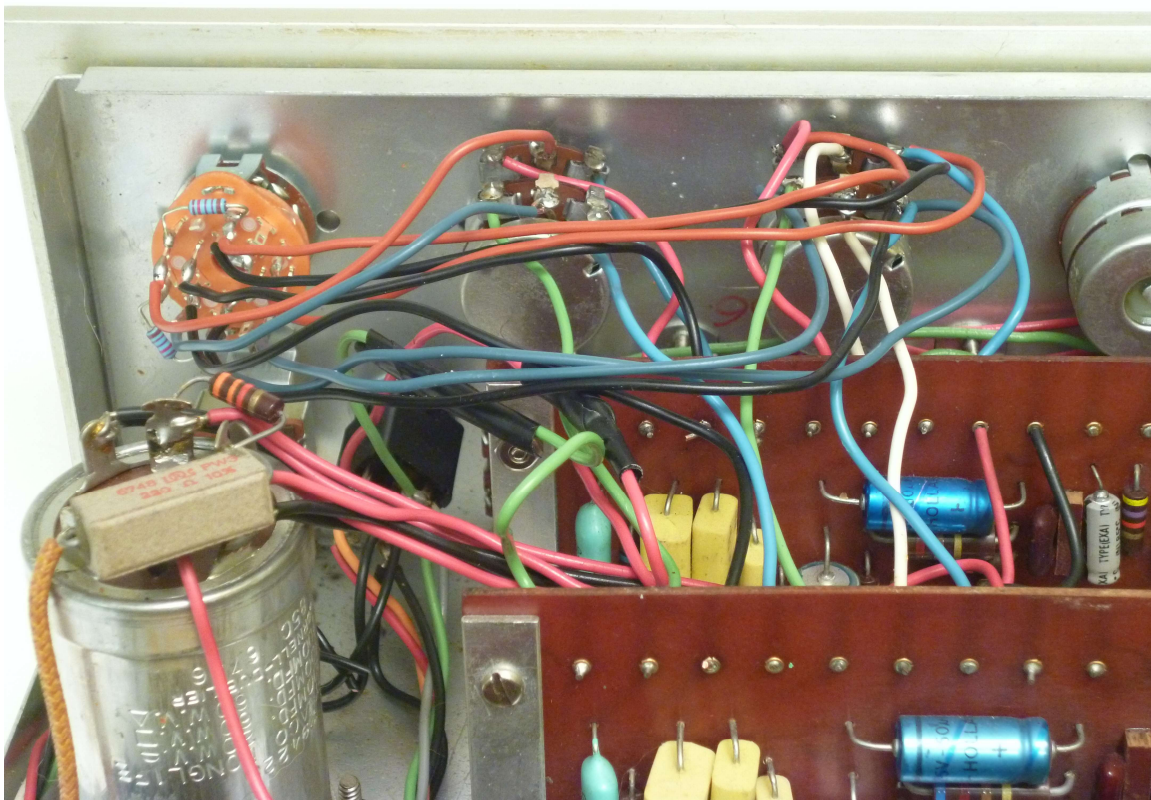

Figure 8-Tone control switch installed and wired to bass control, treble control and PCB's (green wires called out in the assembly directions are blue in the pictures above).

Schematic

Figure 9 shows how the tone control switch fits into the high level amplifier stage.

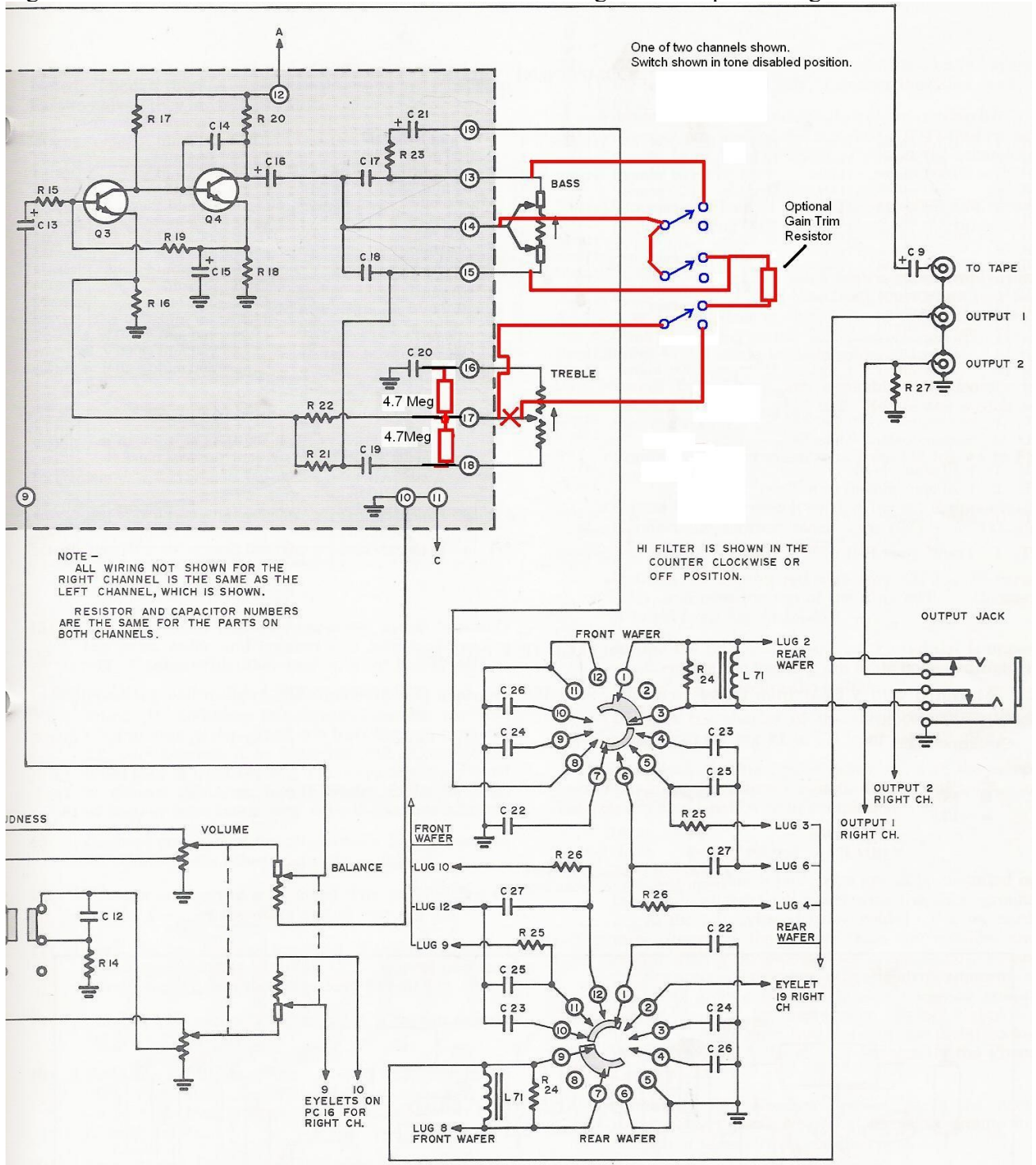

Figure 9-Schematic of the preamp high level stage showing the addition of the tone control switch

Appendix: The Toothpick Trick

This appendix describes an easy way to clear the solder from a hole in the PCB. It can also be used to clear the solder from terminals on pots or jacks. Doing so makes it easier to install a new component, or reinstall wires that were temporarily removed to allow access to some other component.

All you'll need is a soldering iron and some toothpicks with sharp points. The diameter of the pointed part of the toothpick must be smaller than the diameter of the hole that you're trying to clear.

Heat the solder land on the component side of the board until the solder flows. Insert the toothpick from the component side of the board while pushing and twisting the toothpick. If the solder has melted, the toothpick should push through the board, displacing the solder. Remove the soldering iron, but let the toothpick remain in the hole until the solder has solidified. Now remove the toothpick. There should be a hole through the solder sufficiently large to allow you to insert the component lead or wire.

Sometimes, a bit of the toothpick will break off in the hole. If this happens, use a stiff piece of wire to push the toothpick fragment out of the hole.